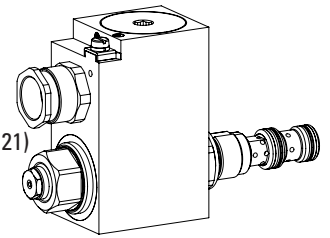

Proportional pressure reducing cartridge

- ◆ direct operated by means of pilot spool
- ◆ $Q_{max} = 20 \text{ l/min}$
- ◆ $p_{max} = 350 \text{ bar}$
- ◆ $p_{N \text{ red max}} = 200 \text{ bar}$

M22 x 1,5
ISO 7789

Ex db IIC T6, T4 Gb (Zone 1)
 Ex tb III C T80 °C, T130 °C Db (Zone 21)
 Ex db I Mb
 ⓧ II 2 G Ex db IIC T6, T4
 ⓧ II 2 D Ex tb III C T80 °C, T130 °C
 ⓧ I M2 Ex db I Mb
 Class I, Division 1, Group A, B, C, D T4
 Class II & III, Division I, Group E, F, G T4

DESCRIPTION

Direct operated proportional pressure reducing valve with pilot spool actuation in screw-in cartridge construction for cavity according to ISO 7789. Proportionally to the solenoid current, the solenoid force and the pressure in port A (1) rise. The valve functions practically independently of the pressure in port P (2). Pressure increase in the consumer port A (1) to above the adjusted value, e.g. through an active consumer, is avoided by discharging excess oil to the tank T (3). With the solenoid deenergised, the oil flows freely from consumer port A (1) to port T (3). For the control, Wandfluh proportional amplifiers are available (see register 1.13). The pressure tight encapsulated Ex-protection solenoid coil prevents an explosion on the inside penetrating to the outside as well as an ignitable surface temperature.

APPLICATION

These valves are suitable for applications in explosion-hazard areas, open cast and also in mines. The electrical remote control in conjunction with process controls allows economical solutions with repeatable processes. The screw-in cartridge is perfectly suitable for installation in control blocks and is installed in sandwich- (vertical stacked systems) and in flange plates (corresponding data sheets in this register). For machining the cartridge cavity in steel and aluminum blocks, cavity tools are available (hire or purchase). Please refer to the data sheets in register 2.13.

TYPE CODE

		M P B PM22 - <input type="checkbox"/> - <input type="checkbox"/> / <input type="checkbox"/> / <input type="checkbox"/> - <input type="checkbox"/> <input type="checkbox"/> # <input type="checkbox"/>			
Pressure reducing valve					
Direct operated by means of pilot spool					
Proportional, explosion proof execution Ex d					
Screw-in cartridge M22 x 1,5					
Execution		L9	L15		
Nominal pressure range p_N [bar]		<input type="checkbox"/> 20	<input type="checkbox"/> 115	<input type="checkbox"/> 20	<input type="checkbox"/> 135
		<input type="checkbox"/> 80	<input type="checkbox"/> 200	<input type="checkbox"/> 95	<input type="checkbox"/> 235
Nominal voltage U_N		12 VDC	<input type="checkbox"/> G12		
		24 VDC	<input type="checkbox"/> G24		
Nominal power P_N		9 W	<input type="checkbox"/> L9	Ambient temperature up to: 40 °C or 90 °C 70 °C	
		15 W	<input type="checkbox"/> L15		
Certification	ATEX, UKEX, IECEx, EAC, CCC	<input type="checkbox"/>	USA / Canada	<input type="checkbox"/> UC-M187	
	Australia	<input type="checkbox"/> AU	India	<input type="checkbox"/> PE	
	MA (nur L15)	<input type="checkbox"/> MA			
Sealing material	NBR	<input type="checkbox"/>			
	FKM (Viton)	<input type="checkbox"/> D1			
Options	without amplifier	<input type="checkbox"/>			
		<input type="checkbox"/> M248			

Design index (subject to change)

2.3-627

CERTIFICATES

	Surface	Mining	Standard -25 °C to...	M248 Electronic
ATEX / UKEX	x	x	x	x
IECEX	x	x	x	x
CCC	x	x	x	x
EAC	x	x	x	x
Australia	x	x	x	
MA		x	x	x
USA / Canada	x		x	x
PESO	x		x	x

The certificates can be found on www.wandfluh.com

GENERAL SPECIFICATIONS

Designation	Proportional pressure reducing valve
Construction	Direct operated by means of pilot spool
Mounting	Screw-in cartridge construction
Nominal size	M22 x 1,5 according to ISO 7789
Actuation	Proportional solenoid
Ambient temperature	Operation as T6 -25...+40 °C (L9) Operation as T4 -25...+90 °C (L9) -25...+70 °C (L15)
Weight	1,95 kg
MTTFd	150 years

ELECTRICAL SPECIFICATIONS

Protection class	IP65 / 66 / 67
Relative duty factor	100 % DF
Voltage tolerance	± 10 % with regard to nominal voltage
Standard nominal voltage	12 VDC, 24 VDC
Limiting current at... °C	L9, 40 °C $I_G = 625 \text{ mA}$ (12 VDC) $I_G = 305 \text{ mA}$ (24 VDC) L15, 50 °C $I_G = 950 \text{ mA}$ (12 VDC) $I_G = 450 \text{ mA}$ (24 VDC) L15, 70 °C $I_G = 910 \text{ mA}$ (12 VDC) $I_G = 420 \text{ mA}$ (24 VDC)
Standard nominal power	9 W, 15 W
Temperature class	Nominal power 9 W: T1...T6 Nominal power 15 W: T1...T4

Note! Other electrical specifications see data sheet 1.1-183

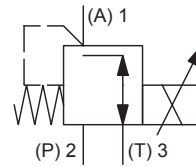
SYMBOL

HYDRAULIC SPECIFICATIONS

Working pressure	$p_{max} = 350 \text{ bar}$
Nominal pressure range	Ausführung L9 $p_N = 20 \text{ bar}, 80 \text{ bar}, 115 \text{ bar}, 200 \text{ bar}$ Ausführung L15 $p_N = 20 \text{ bar}, 95 \text{ bar}, 135 \text{ bar}, 235 \text{ bar}$
Minimum adjustable pressure	< 1 bar
Volume flow range	See characteristic
Leakage oil	at $p_{sys} = 350 \text{ bar}$ < 30 ml/min for $p_{N red} = 20, 80 (95), 115 (135) \text{ bar}$ < 50 ml/min for $p_{N red} = 200 (235) \text{ bar}$
Hysteresis	≤ 5 % at optimal dither signal
Repeatability	≤ 2 % at optimal dither signal
Fluid	Mineral oil, other fluid on request
Viscosity range	12 mm ² /s...320 mm ² /s
Temperature range fluid	Operation as T6 NBR -25...+40 °C (L9) FKM -20...+40 °C (L9) Operation as T4 NBR -25...+70 °C (L9 or L15) FKM -20...+70 °C (L9 or L15)
Contamination efficiency	Class 18 / 16 / 13
Filtration	Required filtration grade $\beta_{6...10} \geq 75$, see data sheet 1.0-50

ACTUATION

Actuation	Proportional solenoid, wet pin push type, pressure tight
Execution	MKY45 / 18x60 (Data sheet 1.1-183)
Connection	Cable gland for cable $\varnothing 6,5...14 \text{ mm}$

Attention! The UC execution is always supplied without cable gland

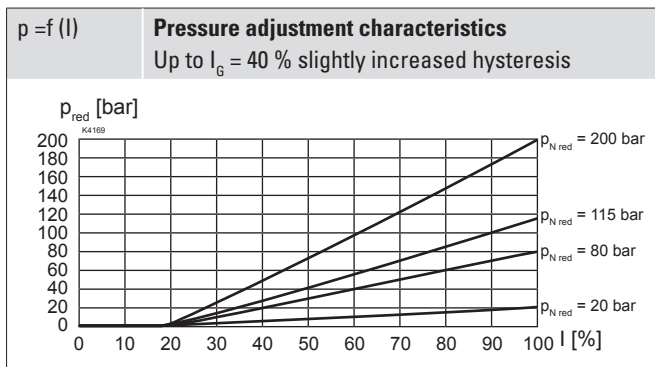
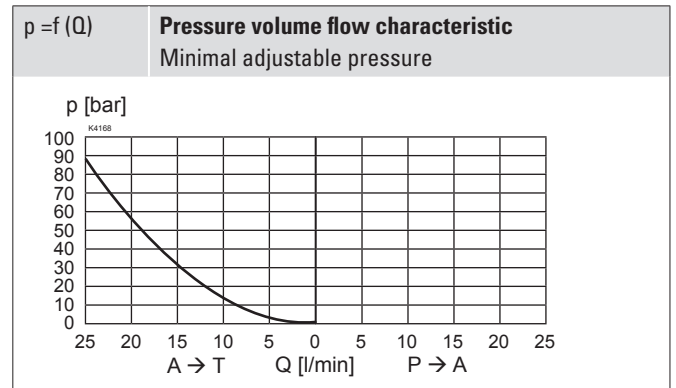
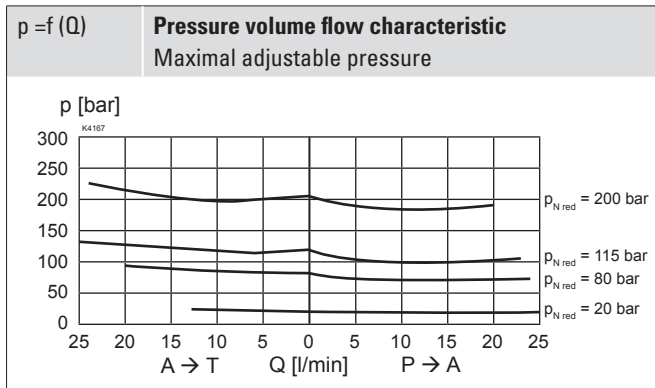

PERFORMANCE SPECIFICATIONS EXECUTION L9 (MEASURED AT 40 °C)

 Oil viscosity $\nu = 30 \text{ mm}^2/\text{s}$

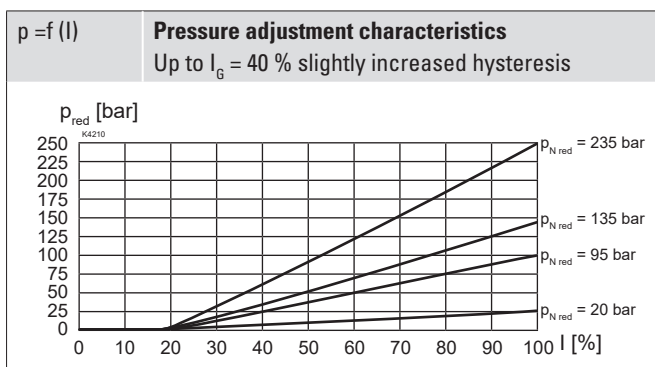
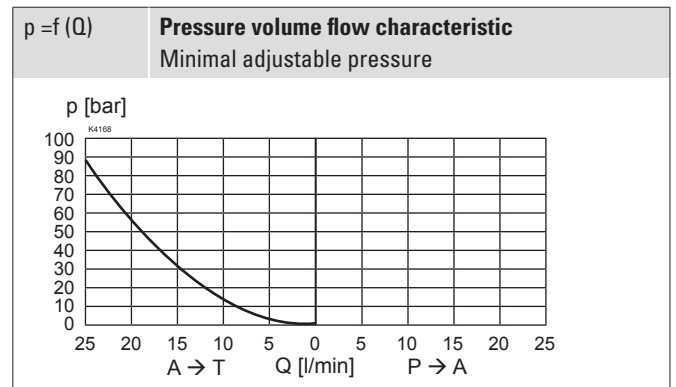
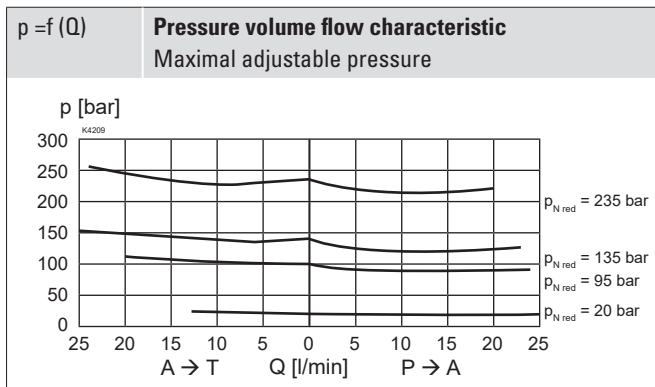
PERFORMANCE SPECIFICATIONS EXECUTION L15 (MEASURED AT 50 °C)

 Oil viscosity $\nu = 30 \text{ mm}^2/\text{s}$

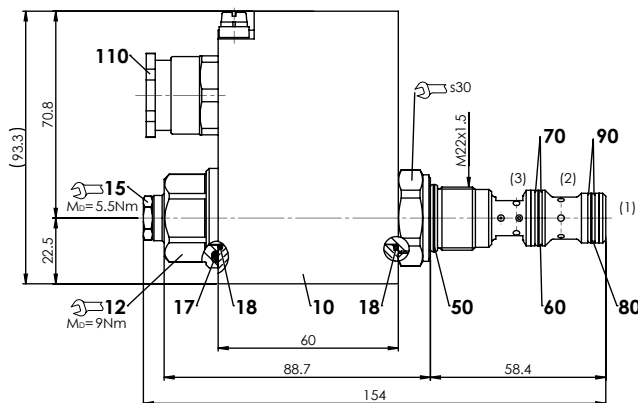
DIMENSIONS



HYDRAULIC CONNECTION

Cavity drawing according to ISO 7789-22-04-0-98

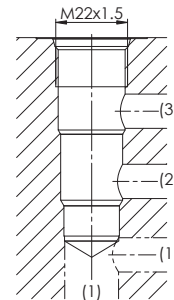

Note!



For detailed cavity drawing and cavity tools see data sheet 2.13-1004

PARTS LIST

Position	Article	Description
10	263.6...	Solenoid coil MK.45 / 18 x 60
12	154.2603	Knurled nut Ex M18 x 1,5 x 18
15	253.8000	Manual override HB4,5
110	111.1080	Cable gland M20 x 1,5
	251.3106	Seal kit NBR
	251.3115	Seal kit D1

Seal kit consisting of:

17	O-ring	ID 25,07 x 2,62
18	O-ring	ID 17,17 x 1,78
50	O-ring	ID 18,77 x 1,78
60	O-ring	ID 15,60 x 1,78
70	Back. ring	PTFE rd 16,1 x 19 x 1,4
80	O-ring	ID 14,00 x 1,78
90	Back. ring	PTFE rd 14,1 x 17 x 1,4

ACCESSORIES

Proportional amplifier	Register 1.13
Flange body / sandwich plate NG4-Mini	Data sheet 2.3-820
Flange body / sandwich plate NG6	Data sheet 2.3-840
Flange body / sandwich plate NG10	Data sheet 2.3-860
Threaded body	Data sheet 2.9-210
Technical explanations	Data sheet 1.0-100
Filtration	Data sheet 1.0-50

MANUAL OVERRIDE

Standard HB4,5

Optionally: Screw plug (HB0), no actuation possible.

Attention! If the manual override is actuated, the nominal pressure level may be exceeded.

SURFACE TREATMENT

- ◆ The cartridge body, the slip-on coil and the armature tube are zinc-nickel coated

STANDARDS

Cartridge cavity	ISO 7789
Explosion protection	Directive 2014 / 34 / EU (ATEX)
Flameproof enclosure	EN / IEC / UL 60079-1, 31
Cable entry	EN 60079-0, 1, 7, 15, 31
Protection class	EN 60 529
Contamination efficiency	ISO 4406

COMMISSIONING

Attention! The solenoid coil must only be put into operation, if the requirements of the operating instructions supplied are observed to their full extent. In case of non-observance, no liability can be assumed.

SEALING MATERIAL

NBR or FKM (Viton) as standard, choice in the type code

INSTALLATION NOTES

Mounting type	Screw-in cartridge M22 x 1,5
Mounting position	Any, preferably horizontal
Tightening torque	$M_D = 60$ Nm Screw-in cartridge $M_D = 9$ Nm knurled nut

Attention! For stack assembly please observe the remarks in the operating instructions
