

Solenoid operated poppet valve cartridge

- ◆ solenoid actuated
- ◆ pilot operated
- ◆ normally open and normally closed
- ◆ 2/2-way
- ◆ $Q_{max} = 150 \text{ l/min}$
- ◆ $p_{max} = 350 \text{ bar}$

DESCRIPTION

Pilot operated 2/2-way solenoid poppet valve in screw-in cartridge construction for cavity according to ISO 7789. The AB and CB execution is closed in the energised position, the BA and BC execution in the de-energised position. In this, the main spool closes practically leakage-free by means of the applied pressure. In the opposite flow direction, the valve opens after reaching the opening pressure. The pressure tight encapsulated Ex-protection solenoid coil prevents an explosion on the inside penetrating to the outside as well as an ignitable surface temperature.

CERTIFICATES

| | Surface | Mining | Standard -25 °C to... | Z604 -40 °C to... |
|-----------------|---------|--------|--------------------------|----------------------|
| ATEX / UKEX | x | x | x | x |
| IECEX | x | x | x | x |
| CCC | x | x | x | x |
| EAC | x | x | x | x |
| Australia | x | x | x | x |
| MA | | x | x | |
| USA / Canada | x | | x | x |
| PESO | x | | x | x |

The certificates can be found on www.wandfluh.com

SYMBOL

„Normally open“ AB

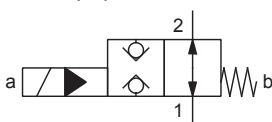

„Normally closed“ BA

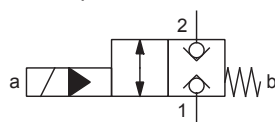

„Normally closed“ BC

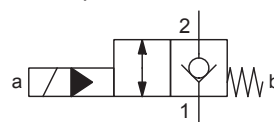

„Normally open“ CB

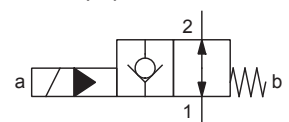

M33 x 2 ISO 7789

Ex db IIC T6, T4 Gb (Zone 1)
 Ex tb III C T80 °C, T130 °C Db (Zone 21)
 Ex db I Mb
 ⚠ II 2 G Ex db IIC T6, T4
 ⚠ II 2 D Ex tb III C T80 °C, T130 °C
 ⚠ I M2 Ex db I Mb
 Class I, Division 1, Group A, B, C, D T4
 Class II & III, Division I, Group E, F, G T4

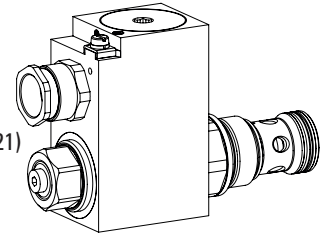

APPLICATION

These valves are suitable for applications in explosion-hazard areas, open cast and also in mines. Poppet valves are used where tight closing functions of the valve are essential like leakage-free load holding, clamping or gripping. For machining the cartridge cavity in steel and aluminum blocks, cavity tools are available (hire or purchase). Please refer to the data sheets in register 2.13.

ACTUATION

| | |
|------------|--|
| Actuation | Switching solenoid, wet pin push + pull type, pressure tight |
| Execution | MKY45 / 18x60 (data sheet 1.1-183) |
| Connection | Cable gland for cable Ø 6,5...14 mm |

Attention! The UC execution is always supplied without cable gland



TYPE CODE

| | | | | | | | |
|--------------------------------------|---|---|---|--|---|--|------------------|
| | | S V Y PM33 - <input type="text"/> - <input type="text"/> / <input type="text"/> <input type="text"/> - <input type="text"/> <input type="text"/> # <input type="text"/> | | | | | |
| Poppet valve | | | | | | | |
| Pilot operated | | | | | | | |
| Ex-protection execution, Exd | | | | | | | |
| Screw-in cartridge M33 x 2 | | | | | | | |
| Designation of symbols acc. to table | | | | | | | |
| Nominal voltage U _N | 12 VDC <input type="text"/> <input type="text"/> <input type="text"/> <input type="text"/> <input type="text"/> | <input type="text"/> <input type="text"/> <input type="text"/> <input type="text"/> <input type="text"/> | 115 VAC <input type="text"/> <input type="text"/> <input type="text"/> <input type="text"/> <input type="text"/> | <input type="text"/> <input type="text"/> <input type="text"/> <input type="text"/> <input type="text"/> | | | |
| | 24 VDC <input type="text"/> <input type="text"/> <input type="text"/> <input type="text"/> <input type="text"/> | <input type="text"/> <input type="text"/> <input type="text"/> <input type="text"/> <input type="text"/> | 230 VAC <input type="text"/> <input type="text"/> <input type="text"/> <input type="text"/> <input type="text"/> | <input type="text"/> <input type="text"/> <input type="text"/> <input type="text"/> <input type="text"/> | | | |
| Nominal power P _N | 9 W <input type="text"/> <input type="text"/> <input type="text"/> <input type="text"/> <input type="text"/> | <input type="text"/> <input type="text"/> <input type="text"/> <input type="text"/> <input type="text"/> | Ambient temperature up to: | | | | |
| | 15 W <input type="text"/> <input type="text"/> <input type="text"/> <input type="text"/> <input type="text"/> | <input type="text"/> <input type="text"/> <input type="text"/> <input type="text"/> <input type="text"/> | 40 °C or 90 °C | | | | |
| | | | 70 °C | | | | |
| Certification | ATEX / UKEX, IECEx, EAC, CCC <input type="text"/> <input type="text"/> <input type="text"/> <input type="text"/> <input type="text"/> | <input type="text"/> <input type="text"/> <input type="text"/> <input type="text"/> <input type="text"/> | USA / Canada <input type="text"/> <input type="text"/> <input type="text"/> <input type="text"/> <input type="text"/> | <input type="text"/> <input type="text"/> <input type="text"/> <input type="text"/> <input type="text"/> | India <input type="text"/> <input type="text"/> <input type="text"/> <input type="text"/> <input type="text"/> | | |
| | Australia <input type="text"/> <input type="text"/> <input type="text"/> <input type="text"/> <input type="text"/> | <input type="text"/> <input type="text"/> <input type="text"/> <input type="text"/> <input type="text"/> | | | | | |
| | MA <input type="text"/> <input type="text"/> <input type="text"/> <input type="text"/> <input type="text"/> | <input type="text"/> <input type="text"/> <input type="text"/> <input type="text"/> <input type="text"/> | | | | | |
| Sealing material | NBR <input type="text"/> <input type="text"/> <input type="text"/> <input type="text"/> <input type="text"/> | <input type="text"/> <input type="text"/> <input type="text"/> <input type="text"/> <input type="text"/> | FKM (Viton) <input type="text"/> <input type="text"/> <input type="text"/> <input type="text"/> <input type="text"/> | <input type="text"/> <input type="text"/> <input type="text"/> <input type="text"/> <input type="text"/> | NBR -40 °C <input type="text"/> <input type="text"/> <input type="text"/> <input type="text"/> <input type="text"/> | | (only with 15 W) |
| Armature tube | with screw plug HBO <input type="text"/> <input type="text"/> <input type="text"/> <input type="text"/> <input type="text"/> | <input type="text"/> <input type="text"/> <input type="text"/> <input type="text"/> <input type="text"/> | with manual override <input type="text"/> <input type="text"/> <input type="text"/> <input type="text"/> <input type="text"/> | <input type="text"/> <input type="text"/> <input type="text"/> <input type="text"/> <input type="text"/> | | | (only AB, CB) |
| Design index (subject to change) | | | | | | | |
| 1.11-2085 | | | | | | | |

GENERAL SPECIFICATIONS

| | |
|---------------------|--|
| Designation | 2/2-way poppet valve |
| Construction | Pilot operated |
| Mounting | Screw-in cartridge construction |
| Nominal size | M33 x 2 according to ISO 7789 |
| Actuation | Ex-protection switching solenoid |
| Ambient temperature | Operation as T6 -25...+40 °C (L9) Operation as T4 -25...+90 °C (L9) -25...+70 °C (L15) -40...+70 °C (L15) |
| Weight | 2,45 kg |
| MTTFd | 150 years |

HYDRAULIC SPECIFICATIONS

| | |
|--------------------------|--|
| Working pressure | p _{max} = 350 bar |
| Opening pressure | 1,5 bar 1 → 2 version BC / CB 2,0 bar 2 → 1 version BC / CB 3,0 bar 1 → 2 version AB / BA 3,0 bar 2 → 1 version AB / BA |
| Maximum volume flow | Q _{max} = 150 l/min, see characteristics |
| Leakage oil | Poppet type, max. 0,15 ml / min (approx. 3 drops / min) at 30 cSt |
| Fluid | Mineral oil, other fluid on request |
| Viscosity range | 12 mm ² /s...320 mm ² /s |
| Temperature range fluid | Operation as T6 NBR -25...+40 °C (L9) FKM -20...+40 °C (L9) Operation as T4 NBR -25...+70 °C (L9 or L15) FKM -20...+70 °C (L9 or L15) NBR 872 -40...+70 °C (L15) |
| Contamination efficiency | Class 20 / 18 / 14 |
| Filtration | Required filtration grade β 10...16 ≥ 75, see data sheet 1.0-50 |

ELECTRICAL SPECIFICATIONS

| | |
|--------------------------|--|
| Protection class | IP65 / 66 / 67 |
| Relative duty factor | 100 % DF |
| Switching frequency | 5'000 / h |
| Voltage tolerance | ± 10 % with regard to nominal voltage |
| Standard nominal voltage | 12 VDC, 24VDC, 115 VAC, 230 VAC AC = 50 to 60 Hz ± 2 %, with built-in two-way rectifier |
| Standard nominal power | 9 W, 15 W |
| Temperature class | Nominal power 9 W: T1...T6 Nominal power 15 W: T1...T4 |

Note! Other electrical specifications see data sheet 1.1-183



PERFORMANCE SPECIFICATIONS

Oil viscosity $\nu = 30 \text{ mm}^2/\text{s}$

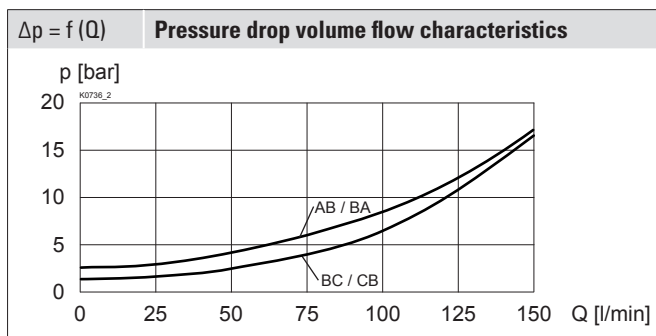
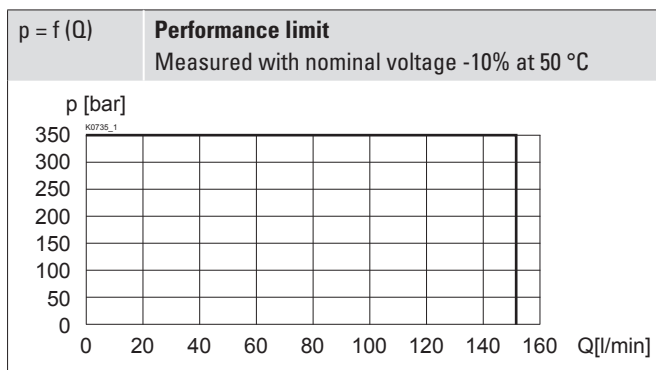

SURFACE TREATMENT

- ◆ The cartridge body, the slip-on coil and the armature tube are zinc-nickel coated

STANDARDS

| | |
|--------------------------|---------------------------------|
| Cartridge cavity | ISO 7789 |
| Explosion protection | Directive 2014 / 34 / EU (ATEX) |
| Flameproof enclosure | EN / IEC / UL 60079-1, 31 |
| Cable entry | EN 60079-0, 1, 7, 15, 31 |
| Protection class | EN 60 529 |
| Contamination efficiency | ISO 4406 |

Switching times

| SVYPM33 | Type | Flow direction | Energised | De-energised |
|---------|------|----------------|----------------|----------------|
| | AB | 1 → 2 | approx. 100 ms | approx. 60 ms |
| | | 2 → 1 | approx. 100 ms | approx. 80 ms |
| | BA | 1 → 2 | approx. 30 ms | approx. 100 ms |
| | | 2 → 1 | approx. 30 ms | approx. 100 ms |
| | BC | 2 → 1 | approx. 30 ms | approx. 70 ms |
| | CB | 2 → 1 | approx. 60 ms | approx. 70 ms |

Note!



With the L15 execution for ambient temperatures up to 70 °C, the characteristics have been evaluated with an ambient temperature of 50 °C.

The switching times depend on the volume flow, pressure and viscosity. In case of small volume flows, the switching time can get considerably longer.

Attention!



Long periods of non-actuation can reduce the switching performance

MANUAL OVERRIDE

Screw plug (HB0), no actuation possible.

Optionally HN (K) or HG (K) (pushing) resp. HZ (K) (pulling)

→ See data sheet 1.1-311

Attention!



The manual override HZ (K) can neither be dismantled nor retrofitted

DIMENSIONS

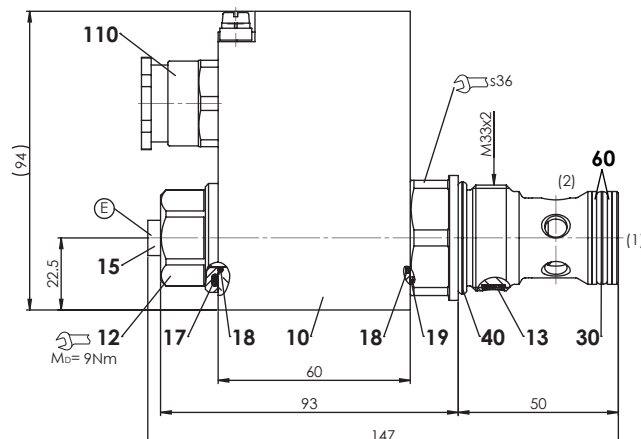

E = Air bleed screw

Dimensions of the solenoid coil see data sheet 1.1-183

PARTS LIST

| Position | Article | Description |
|----------|----------|-------------------------------|
| 10 | 263.6... | Solenoid coil MK.45 / 18 x 60 |
| 12 | 154.2603 | Knurled nut Ex M18 x 1,5 x 18 |
| 13 | 212.0013 | Plastic disc rd 7 x 1,5 |
| 15 | 239.2033 | Screw plug HB0 (incl. seal) |
| 110 | 111.1080 | Cable gland M20 x 1,5 |
| - | 251.3009 | Seal kit SV.PM33 NBR |
| | 251.3026 | Seal kit SV.PM33 D1 |
| | 251.3019 | Seal kit SV.PM33 Z604 |

Seal kit consisting of

| | | |
|----|------------|-------------------------|
| 17 | O-ring | ID 25,07 x 2,62 |
| 18 | O-ring | ID 17,17 x 1,78 |
| 19 | O-ring | ID 26,00 x 1,00 |
| 30 | O-ring | ID 23,81 x 2,62 |
| 40 | O-ring | ID 29,82 x 2,62 |
| 60 | Back. ring | PTFE rd 24,5 x 29 x 1,4 |

COMMISSIONING

Attention! When commissioning, the valve must be vented under pressure (max. two rotations of screw E).



The solenoid coil must only be put into operation, if the requirements of the operating instructions supplied are observed to their full extent. In case of non-observance, no liability is assumed.

HYDRAULIC CONNECTION

Cavity drawing according to ISO 7789-33-01-0-98

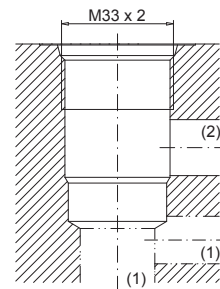

Note!



For detailed cavity drawing and cavity tools see data sheet 2.13-1005

ACCESSORIES

| | |
|------------------------|--------------------|
| Threaded body | Data sheet 2.9-2xx |
| Technical explanations | Data sheet 1.0-100 |
| Filtration | Data sheet 1.0-50 |
| Relative duty factor | Data sheet 1.1-430 |

SEALING MATERIAL

NBR or FKM (Viton) as standard, choice in the type code

INSTALLATION NOTES

| | |
|-------------------|---|
| Mounting type | Screw-in cartridge M33 x 2 |
| Mounting position | Any, preferably horizontal |
| Tightening torque | $M_D = 130 \text{ Nm}$ Screw-in cartridge $M_D = 9 \text{ Nm}$ knurled nut |

Attention!



For stack assembly please observe the remarks in the operating instructions