

Diaphragm Accumulator | 50 - 1315 - 13 - 711 | 0,5 L - 330/0 BAR ESC_VOL_IMP | 110 X 180 MM ESC_IN | Steel /Membrane / Bladder- NBR | CE / PED

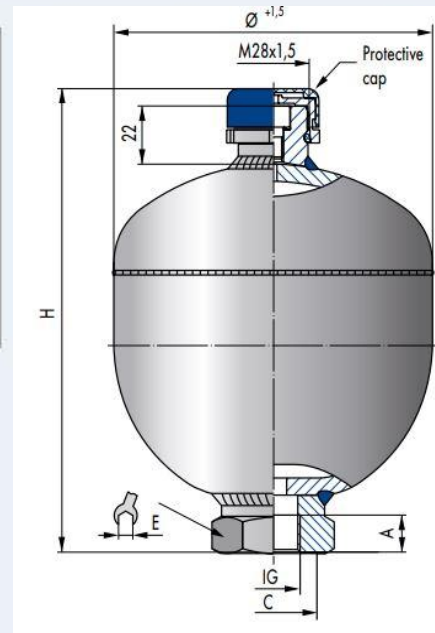
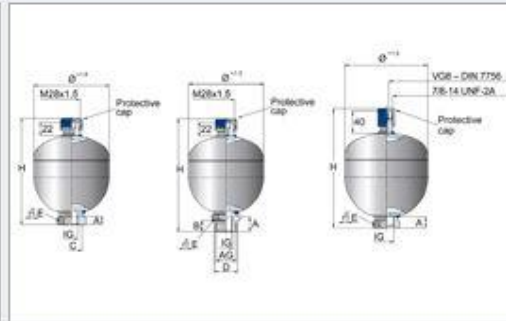

item no.	49315989
availability	on demand
IG	G 1/2
AG	M 33x1,5
gas port	Standard EU M28x1,5
A	24
B	18
certificate	CE / PED
D	39
E	WS 41
outer Ø	110 mm
H	180 mm
material	NBR

Item attributes 49315989 (Accumulator Diaphragm Accumulator)

design	DACC	temperature max. (temp. max.)	80 ° C
brand	Freudenberg	liquid connection OT sealing surface (D)	39
country of origin	DE	oil port wrench size (E)	WS 41
inner thread oil side (IG)	G 1/2	outer diameter (outer Ø)	110 mm
outer thread oil side (AG)	M 33x1,5	height (H)	180 mm
gas port (gas port)	Standard EU M28x1,5	shore hardness	
IG insertion depth oil side (A)	24	material	NBR
AG insertion depth oil side (B)	18	packaging unit	1 pcs.
temperature min. (temp. min.)	-20 ° C	net weight	2742 gr.