

B02-330- 10,00- /219SNOO XOX V P

Artikel no. Basic Model 49373743 | Drawing no. 219-1515-012-711

Item Attributes

Order No.	49373743
IG	G2
Gas connection type	7/8-14 UNF-2A
A [mm]	30
B [mm]	105
Ø [mm]	219
Certificate	CE / PED
E	SW 70
H [mm]	572
Werkstoff-Familie	NBR
Trennmedium	
Nennvolumen in dm³	10
Temp.einsatzbereich min in °C	-20,00
Temp.einsatzbereich max in °C	80,00

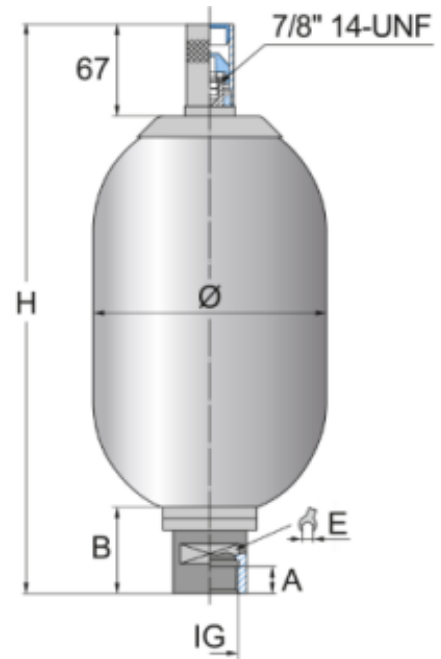

* Catalogue articles do contain a gas pre-charge of 0 bar. Please specify the gas fill pressure, if departing from 0 bar, when placing the order. The article number then differs from the article number of the basic model. .