

B02-350- 6,00- /168SNOO XOG V P

Artikel no. Basic Model 49374490 | Drawing no. 168-1515-012-711

Item Attributes

Order No.	49374490
IG	G1 ¼
Gas connection type	7/8-14 UNF-2A
A [mm]	24
B [mm]	62
Ø [mm]	168
Certificate	CE / PED
E	SW 50
H [mm]	546
Werkstoff-Familie	NBR
Trennmedium	
Nennvolumen in dm³	6
Temp.einsatzbereich min in °C	-20,00
Temp.einsatzbereich max in °C	80,00

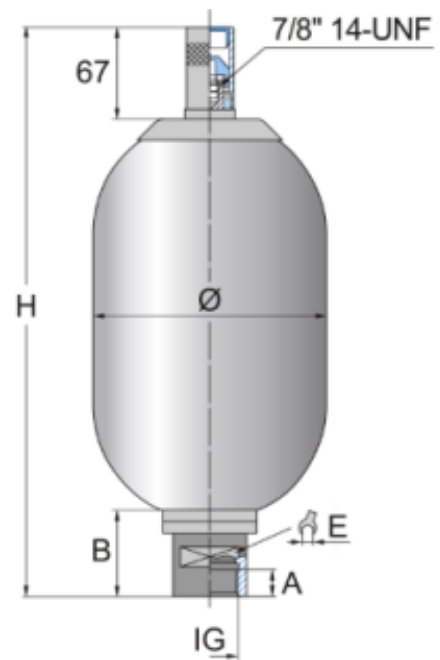

* Catalogue articles do contain a gas pre-charge of 0 bar. Please specify the gas fill pressure, if departing from 0 bar, when placing the order. The article number then differs from the article number of the basic model. .